

InGaAs Focal Plane Arrays for Astronomical Applications

Introduction

InGaAs Focal Plane Arrays, working in the wavelength range from 900 nm to 2,2 μm , are normally not the detectors of choice in near infrared astronomical applications that require lowest noise and highest resolution. However, please be aware of the following product features and possibilities for your specific astronomy problem:

Product features and possibilities

InGaAs Focal Plane Arrays comprise a photosensitive InGaAs-pin-photodiode array combined with a Silicon CMOS Read Out Integrated Circuit (ROIC)

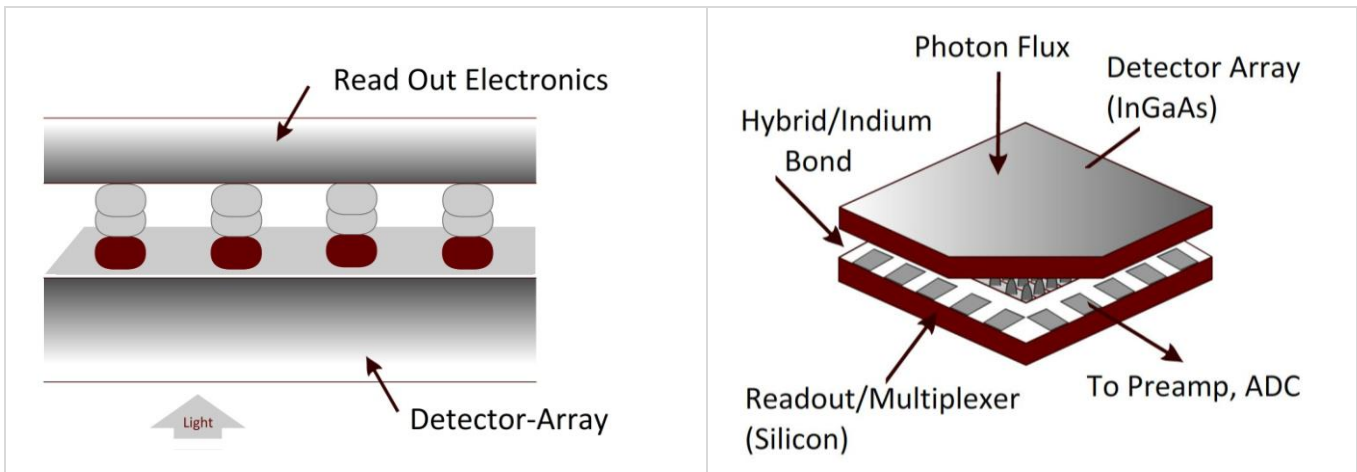

Standard resolutions:

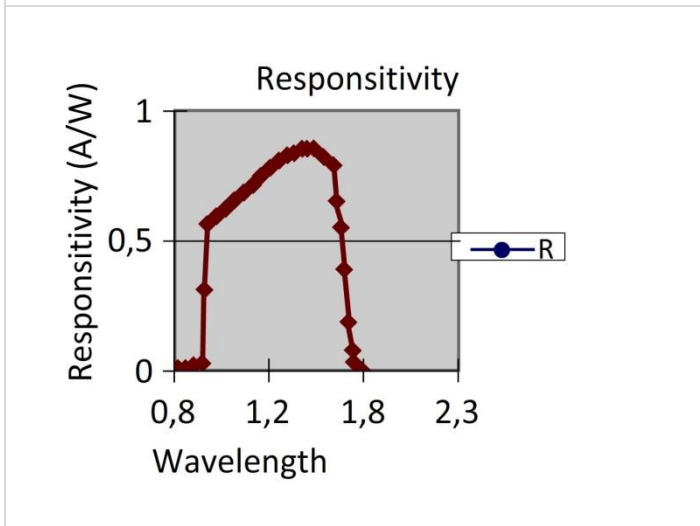
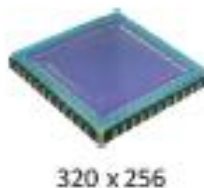

High Quantum Efficiency of > 70% by means of Backilluminated InGaAs/InP Epi technology

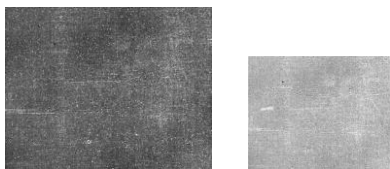

Dark bright

2,2 μm InGaAs

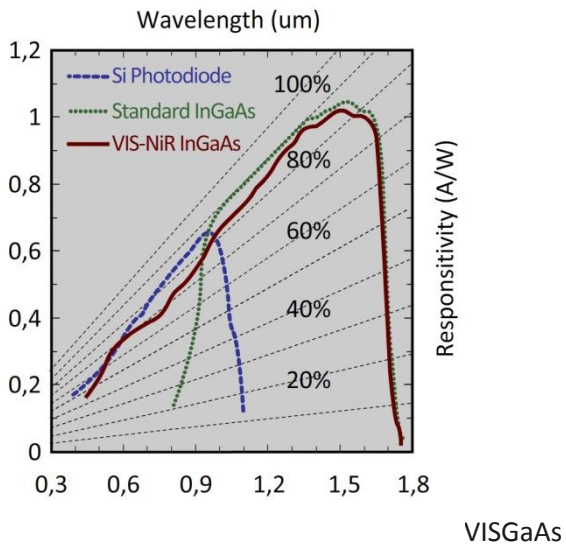

Extension of spectral range into the infrared (2,2 μm , „extended“ InGaAs) and the visible range (VisGaAs) possible.

Long integration time and user friendly read out functions

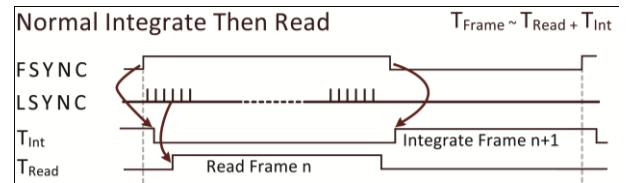
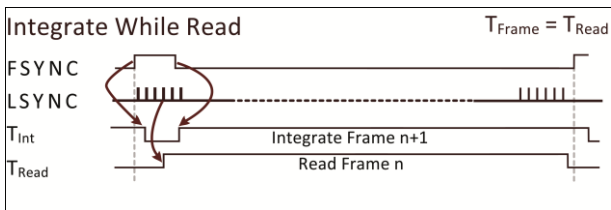

Custom low noise ROIC for high sensitivity applications as astronomy

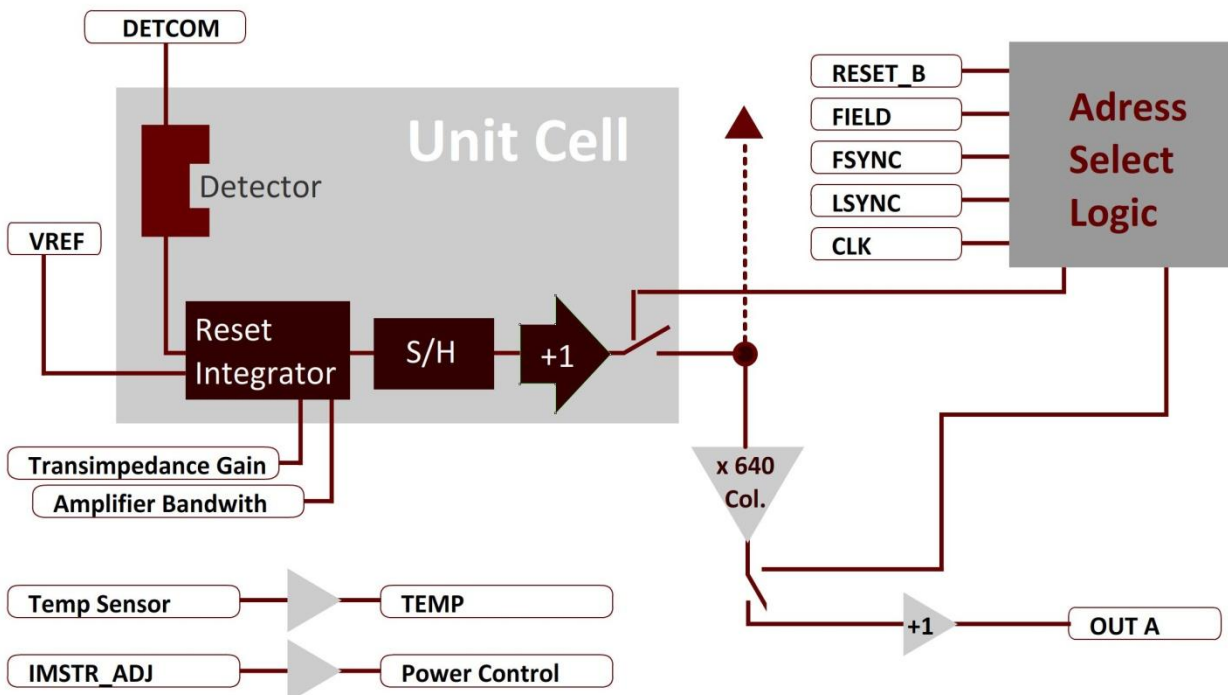

Comparatively low cost

Item	Qty	Part #	Description	Price
1	1	FPA 320x256K	Long integration time and user friendly read out functions Indium-Gallium-Arsenide (InGaAs)-Area Array Detector; Resolution 320x256 pixels, 30 μm pixel size, data rate 10 MHz, Kovar metal package, 1-stage thermoelectric cooler; Spectral Range 0,9 μm 1,7 μm	
2	1	FPA 640x512	Indium-Gallium-Arsenide (InGaAs)-Area Array Detector; Resolution 640 x 512 pixels, 25 μm pixel size, data rate 10 MHz, Kovar metal package, 1-stage thermoelectric cooler; Spectral Range 0,9 μm 1,7 μm	

Application Examples in Astronomy

- Near Infrared Image Acquisition
- Near Infrared Telescopes
- Surveillance
- Near Infrared Spectroscopy
- Humidity Analysis
- Surface Analysis of Objects, Materials

Summary

InGaAs Focal Plane Arrays should be considered as an option in near infrared astronomical applications, that do not call for highest-end noise performance, but require a responsive, fast, flexible, user-friendly and comparatively cost-effective imager solution.